

FAG

6205-C-2HRS

Deep groove ball bearing

Schaeffler ID:
0949834530000Deep groove ball bearing 62...-C-2HRS,
single row, Generation C, seals, steel
sheet metal cage

Technical information

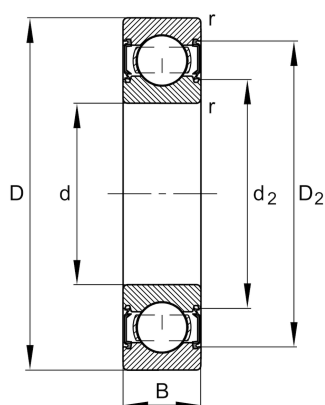
**Dimensions**

r_{\min}	1 mm	Minimum chamfer dimension
D_2	46.4 mm	Caliber diameter outer ring
d_2	31.4 mm	Caliber diameter inner ring
	0.13 kg	Weight

Main Dimensions & Performance Data

d	25 mm	Bore diameter
D	52 mm	Outside diameter
B	15 mm	Width
C_r	15,900 N	Basic dynamic load rating, radial
C_{0r}	7,800 N	Basic static load rating, radial
C_{ur}	530 N	Fatigue load limit, radial
n_G	12,200 1/min	Limiting speed

Mounting dimensions

$d_{a\min}$	30.6 mm	Minimum diameter shaft shoulder
$D_{a\max}$	46.4 mm	Maximum diameter of housing shoulder
$r_{a\max}$	1 mm	Maximum fillet radius

Calculation factors

f_0	13.8	Calculation factor
-------	------	--------------------

Temperature range

T_{\min}	-20 °C	Operating temperature min.
T_{\max}	110 °C	Operating temperature max.

